

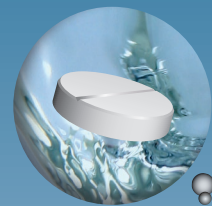

USP 4 Flow-Through Dissolution Systems

SOTAX
Solutions for Pharmaceutical Testing



MR and ER Tablets

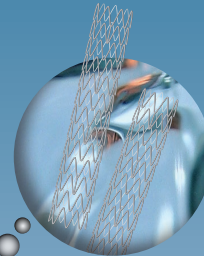

**Medical Devices,
Drug-Eluting Stents
and Implants**

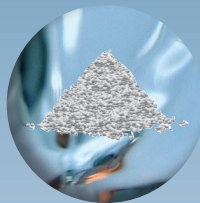

API's and Granules

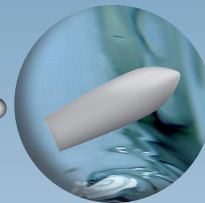

**Suppositories and
Soft Gelatine Capsules**

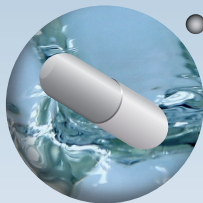
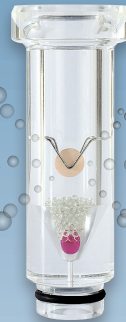

Capsules and Pellets

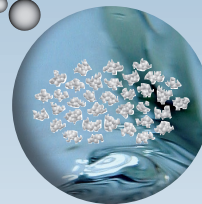

**Microspheres, Microcapsules,
Hydrogels and Liposomes**



www.sotax.com | sotaxusa@sotax.com



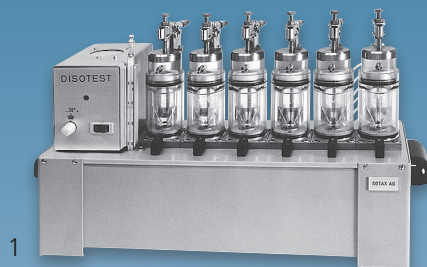

History of USP Apparatus 4 and the Flow-Through Cell

The first documented concept of the Flow-Through Cell technique came as early as 1957 from an FDA laboratory Vliet, E.B.; Letter sent to the USP Subcommittee on tablets, August 23, 1957 proposing an assembly for testing Timed-Release Preparations. In 1968, a continuous flow dissolution apparatus by Pernarowski was described.

However, it was not until the early 1970's that the first conceptual drawings for a true apparatus received from the now creator of the Flow-Through Method, Chemist Dr Langenbucher at Ciba-Geigy was manufactured. Dr Langenbucher, in his visionary article "In Vitro Assessment of Dissolution Kinetics: Description and Evaluation of a Column-type Method" was already predicting what would soon change the testing of modified and extended release dosage forms. SOTAX, a small engineering firm at the time, now considered a global leader in Pharmaceutical Testing Solutions, has been the pioneer ever since in Flow-Through Cell technology designing the first prototype for Dr Langenbucher in 1973. Today, SOTAX is considered 1st in Class and known throughout the world with thousands of companies using USP Apparatus 4.

► Acceptance by Regulatory Authorities Worldwide

It was not until 1981 when the ICH proposed the "Flow-Through" Method as an alternative to basket and paddle methods for poorly soluble and extended release dosage forms that the method started gaining acceptance. The method became an official compendial apparatus when it was accepted by the US and European Pharmacopoeia in 1990 followed by the JP in 1996. Today, USP Apparatus 4 can be found in USP <711> Dissolution for Immediate Release Dosages and USP <724> Drug Release for Extended Release testing. It describes the specifications for the instrument, flow cells and methodology. Today, several monographs and NDAs have been approved by health authorities.

► The Flow-Through Cell Today

Flow-Through Cell is widely recommended for poorly soluble, modified release and extended release tablets, and medical devices. With the evolution of new drug delivery platforms, USP Apparatus 4 has also been used for IVIVC studies, suspensions, injectables, drug coated medical devices, parenteral formulations, implants, gels, ointments, creams, liquids, ophthalmic solutions and lenses, suppositories, soft gelatin capsules, beads, granules, APIs, microspheres and more. The Flow-Through Cell can now be recommended for most novel dosage forms and was used for the first accepted submission for a drug-eluting stent on the market. Because of the method's highly flexible configurations, ability to work in a variety of solubility conditions, Flow-Through Cell types and positioning of the dosage form, hydrodynamics and flow rates, USP Apparatus 4 will continue to evolve to meet the changing needs of today's dissolution and elution testing.

Methodology

► Dissolution Testing according to the Flow-Through Method

In the Flow-Through Method, the test sample is located in a small volume cell through which media is pumped at a temperature of 37 °C. The eluate is filtered upon leaving the cell and then can be analyzed directly or collected in fractions to calculate the percent drug release.



► Open Loop Configuration

Originally designed for poorly soluble compounds where more than the compendial USP 1, 2 and 3 media volumes was required, the Flow-Through Cell system has always been linked to “optimal sink conditions” allowing for complete flexibility in terms of media volume required. In the “open loop” configuration, fresh media crosses the dosage form. Samples are collected as fractions within a defined time interval, analyzed on-line by a UV-Vis spectrophotometer or a fiber optic probe. The total amount of media is determined by the flow rate. This means that the influence of poor sink conditions on the test can be avoided altogether by using larger volumes of media without the need for solubilizing agents. In an open loop configuration, the total media volume used can be infinite.

► Automated Media Change

In the open loop configuration, it is also possible to change the type of media that passes through the flow cell after predefined time intervals. Using the MS47 media selector, media is automatically switched to draw from a different source. Up to 3 different medias can be programmed. Biorelevant Dissolution Media can also be used depending on filter performance. This feature is useful for performing IVIVC studies where the dosage form naturally passes through the different pH of the digestive tract within sink conditions. Studies have shown improved correlations due in part to maintaining sink conditions as well as differing hydrodynamics in the Flow-Through Cell. It is also useful for enteric coated products, modified release and extended release products. Unlike the USP Apparatus 1, 2 and 3 methods where a physical removal of the dosage and change to a new media can be cumbersome and tedious, USP 4 maintains temperature control and dosage integrity even on disintegrating and light sensitive formulations. The Flow-Through Method is the only method that allows for a media change on a suspension and a powder.

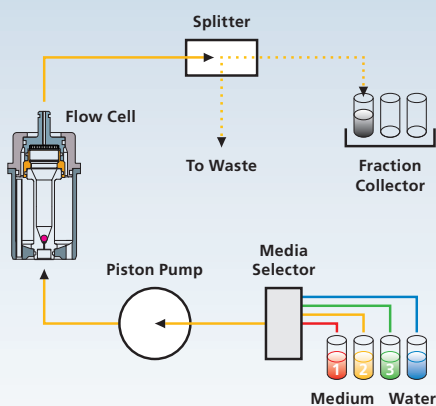

Open system off-line with splitter, fraction collector and media selector



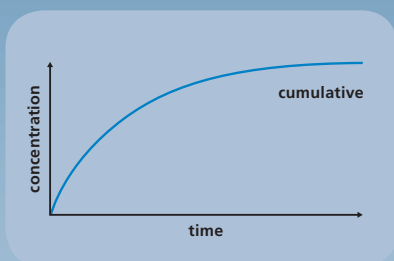
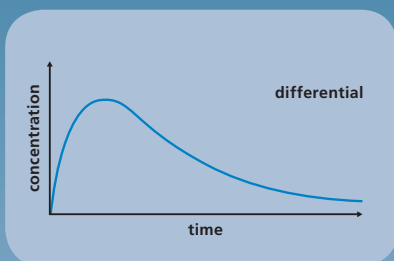

► **Calculations in an Open Loop**

In an open loop configuration, results are calculated as a differential curve or rate of release of the drug over time. Samples are collected and withdrawn as a fraction over a timed interval. The first step is to calculate the concentration of drug in each collected sample. The next step is to calculate the amount of drug in each fraction interval using the following equation:

$$\text{Amount dissolved (mg)} = \frac{\text{Concentration Sample}^*}{1000} (\text{Flow rate} * \text{time interval})$$

You can then calculate the percent drug at each interval. It is also possible to convert the profile into a cumulative release profile by adding the intervals together.

► **Closed Loop Configuration**

In a closed system, the Flow Through Method is conducted much like USP Apparatus 1 and 2 where a fixed volume of media circulates across the dosage form. Samples can be taken a predetermined time by an autosampler, read by an on-line UV or a fiber optic probe. Results of drug dissolved are expressed as a cumulative dissolution curve. Closed systems are ideal for dosage forms where solubility and sink conditions are optimal in a volume range from 50 ml to 2 L. USP 4 offers another possible way to compare results with traditional 250 ml, 500 ml, 900 ml, 1 L, 2 L paddle, baskets and USP 3 methods. This method also provides advantages over other USP methods such as different hydrodynamic and mixing effects eliminating the coning or dead zones seen in USP 1 and 2 as well as sampling issues and sample introduction effects.

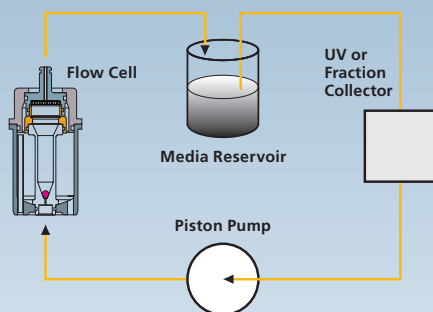

Closed system with UV on-line or with fraction collector



► **Evolution to Small Volume Dissolution and Elution Testing**

As a direct result of low dose formulations such as drug eluting stents, implants, coated medical devices, injectables, and microspheres, the USP 4 method has evolved to fulfill even lower media volume testing. Within the medical device field, the term dissolution has been replaced by "elution" where the amount of drug released from a polymer coating or drug depot is measured. These drug amounts are often so low that in order to meet sensitivity issues for analysis, the total media volume had to be decreased. The USP Apparatus 4 was modified to run in the range of 5–50 ml total volume. In 2007, a new USP Apparatus 4 was developed using a microvolume autosampler that can take accurate samples as low as 100 ul into capped vials.



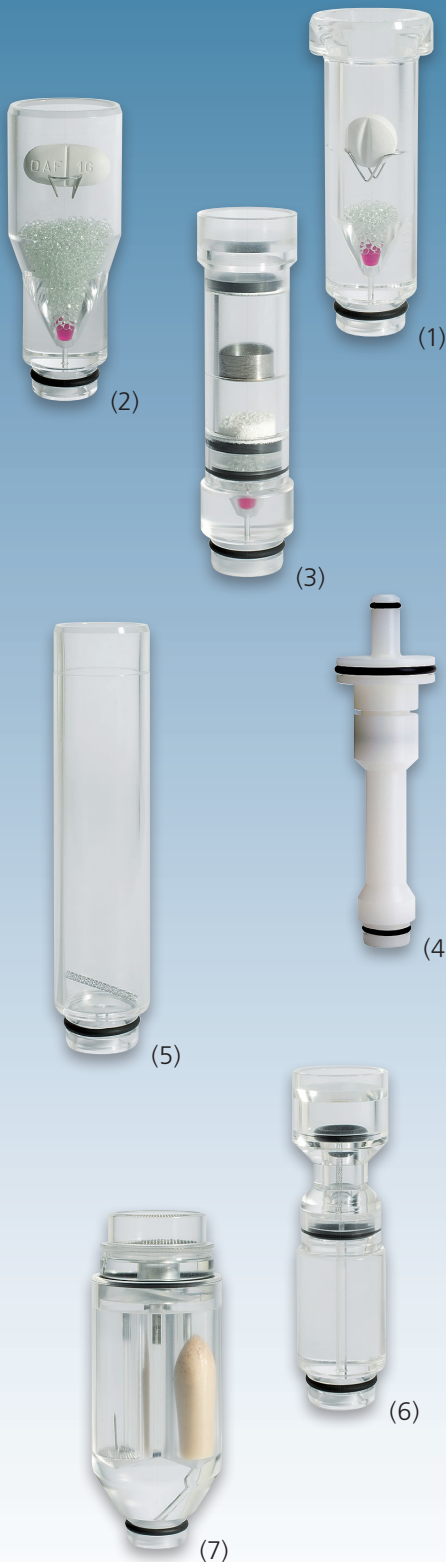

Flow-Through Cells for a Variety of Dosage Forms

The SOTAX CE 7smart is capable of employing the Flow-Through Method for many different dosage forms. As the method evolved, new cells have been developed and optimized according to the dosage form. The position of the sample can be addressed by the choice of the cell and its internal arrangement. Possibilities include solutions for suspension and injectable introduction, powder and granule dissolution, drug eluting stents and implant positioning, and oils and fats associated with soft gelatin capsules and suppository testing.

Eight main cell types are available to accommodate most dosage forms

- ▶ **Tablet Cell 12 mm (1)**
This cell is described in the EP, USP and JP as a small cell for tablets and capsules. A tablet holder is also described. It is also used for suspensions, injectables, small medical devices and stents.
- ▶ **Tablet Cell 22.6 mm (2)**
This cell is described in the EP, USP and JP as a large cell for tablets and capsules. A tablet holder is also described. It can be used for larger doses of a suspensions and microspheres. There are a variety of holding devices developed for this cell. This is the most widely used of all Flow-Through Cells.
- ▶ **Cell for powders and granulates (3)**
This cell is described in the EP chapter 2.9.43 Apparent Dissolution and is used to determine the apparent dissolution rate of pure solid substances (API characterization) and of active substances in preparations presented as powders. It is also used for granule and bead formulations.
- ▶ **Cell for Drug Eluting Stents (4)**
This cell is manufactured in teflon and is used for Medical Devices like Drug Eluting Stents. It eliminates potential adsorption problems encountered with Polycarbonate cells. The inner diameter can be custom manufacture to fit the medical device accordingly.
- ▶ **Cell for Large Medical Devices (5)**
This cell can be used for longer Medical Devices and has a maximum length of 80 mm.
- ▶ **Cell for implants (6)**
This cell is used for small implants and has a small chamber to house the dosage.
- ▶ **Cell for suppositories and soft gelatin capsules (7)**
This cell is described in the EP Chapter 2.9.42 „Dissolution test for lipophilic dosage forms“ and has a special two chambers design which blocks the lipidic excipients and allows the dissolution media to pass up to the filter.

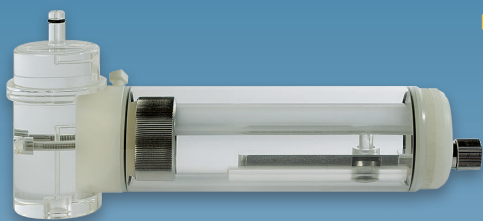

(8)

▶ **Cell for Diffusion/Convection study (8)**

This cell has been designed for parenteral forms to simulate a first phase of diffusion and a second phase of convection without using a membrane. It can also be used for the evaluation of topical formulations.

Customized Flow Cells

Dosage Form Specific cells have also been created and designed based around these main models. Customization includes inner diameters, cell length, dosage form holding devices and different materials such as glass.



(9)

▶ **Variety of Holding Devices**

Various dosage form holding devices can be designed for inside the Flow-Through Cell

▶ **Holding Devices for creams and gels (9)**

This cell is based on a 22.6 mm cell. An insert cup allows testing on gels, creams and ointments with a permeation membrane.



(10)

▶ **Holding Devices for Dialysis bag**

This cell is based on a 22.6 mm cell. An insert holder allows testing on nanoparticles contained in a dialysis bag.

▶ **Holding Device for ophthalmic lens (10)**

This cell is based on a 22.6 mm cell. An insert holder allows testing on drug coated ophthalmic lenses.

Method Development Parameters

▶ **Flow rate and the importance of the pump**

In the Flow-Through Method, the pump is responsible for ensuring the most important parameter: the flow rate of the media. The flow rate can be compared with the RPM speed of USP 1 and 2 or the DPM of USP 3. This flow rate must stay constant throughout the duration of the test, even in cases of back pressure created by filter resistance. The USP regulations require a sinusoidal flow profile with a pulse action of 120 +/- 10 pulses per minute. The SOTAX CP 7 Digital Piston Pump has been specifically developed for the USP 4 method. This pump is equipped with 7 valveless ceramic pump heads insuring a very high level of reproducibility and consistency. The maintenance has been considerably reduced. The flow rate can be adjusted from 1.5 to 35 ml/min, fulfilling the USP standard flow rate recommendations of 4, 8 and 16 ml/min. The flow rate can be automatically adjusted through the firmware of the pump or via WinSOTAX Software. A useful method development tool is the pump ability to have different flow rates per channel. This feature is advantageous during the development of a USP 4 dissolution method. Another unique feature of the pump is the automatic calibration/validation option. For this purpose, the pump is linked to a balance (optional) and printer (optional).



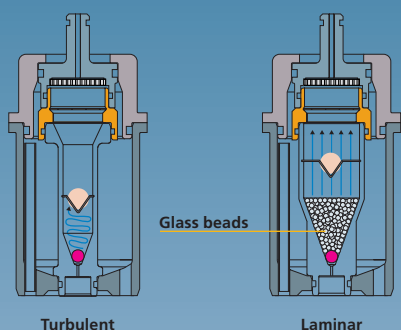

The pump automatically checks and adjusts its flow rate channel per channel based on user-defined volumes. The calibration protocol is then automatically printed out.

► **Laminar vs Turbulent Flow**

There are 2 types of described hydrodynamic flows within Flow-Through Cell. The first is a more turbulent flow path generated by the pulsation of the pump at 120 pulses per min. This type of flow is more beneficial for dosage forms that require a higher agitation rate to release its active. The second type of flow is termed laminar. Laminar flow is achieved by filling the flow cell with 1 mm glass beads described in the USP. The flow is more controlled as it cross the dosage form. In some cases, the dosage form can lay on the surface of the beads, can be sandwiched in between or even mixed with the glass beads.

► **Flexibility of dosage form positioning**

Solid Dosage Forms

The Flow-Through Cell was immediately identified in R&D as a powerful technique due to the numerous possibilities in positioning the dosage form. Solid Dosage forms can be simply placed in the cell, positioned uniformly in a tablet clip holder or placed on glass beads. This all takes place before the test has even begun. This can eliminate variables caused by introduction of a tablet to a vessel, tablet sticking, swelling and floating as seen in the paddle method.



Suspensions

Injectable and Suspension formulations can also be positioned uniformly within the cell on a layer of glass beads. This eliminates some of the common challenges for suspensions within the paddle method including reproducible sample introduction, sampling irregularities, and mixing effects.

Powder and Apparent Dissolution Testing

Traditional methods of powders characterization involve one of several ways:

1. Sprinkle into a standard dissolution vessel
2. Fill an empty capsule
3. Intrinsic Dissolution

However each of these different methods pose several challenges such as wettability of the powder, powder floating on the surface of the media in the vessel or sticking to the shaft, the dead zone underneath the paddle or a tedious compaction of the powder into a tablet. Using the method defined by Apparent Dissolution described in the European Pharmacopoeia Chapter 2.9.43, the USP 4 Powder Cell can be used. In this method, the powder is simply filled into the cell without the need for compression or compaction. Apparent Dissolution is used to characterize the dissolution profile of the API and can be more discriminating and reproducible than these traditional methods.





Suppository and Soft Gelatin Testing (1)

The Suppository and Soft Gelatin Capules Flow cell is a two compartment flow cell. The purpose of this cell is to prevent the fats and oils associated with these types of dosage forms from floating on the surface of the dissolution vessel as seen in the paddle method. This cell allows the media to Flow-Through the dosage without clogging the filter.

Microsphere Testing (2)

Microsphere formulations can be loaded in the flow cell much like that of a suspension. It can be placed within a layer of glass beads or mixed within the beads. Glass beads are useful with this type of formulation to prevent agglomeration.

Implant and Drug Eluting Stent (3)

The implant cell can be used for small subcutaneous rods or stents. Because these dosage forms come in a variety of sizes, SOTAX also offers custom manufacture cells based on specific dimensions. These products are allowed to reside within the cell without the need for a holding device.



► **Filtering (4)**

Filtering occurs at the top of the cell with a filter insert. The standard filter size is 25 mm. It is possible to filter in a variety of pore sizes and materials. In some cases, multiple filters can be layered from larger to smaller pore size. The use of glass wool in the filter head can be used for dosage forms with heavy insoluble or sticky particulate.



Configurations to fit your Method requirements

► **Analytical options and versatility**

When it comes time to analyze the dissolution samples, the SOTAX CE 7smart can be connected to multiple components affording the end user great flexibility. The CE 7smart can be fitted with either a UV-Vis spectrophotometer for „on-line“ UV measurements, a fraction collector to collect portions of samples for analysis by HPLC or an autosampler for collection into capped HPLC vials.

► **USP Compliant at any Media Volume**

Unlike the other compendial USP Apparatus, USP Apparatus 4 has no media volume limits offering maximum flexibility in defining solubility condition and sink conditions.

Open Loop Configurations

Open loop configurations are generally used when the active is poorly soluble or a media change is required.

► **Offline Sample Collection**

For off-line analysis during open loop testing, the SOTAX CE 7smart can be connected to a fraction collector with a splitter valve. The splitter valve controls the collection of sample during the timed interval. Unlike an autosampler that

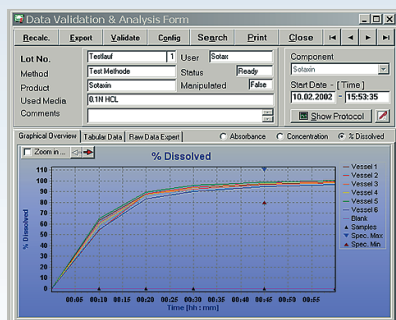



collects at predefined times, the splitter valve takes a representative sample during the entire sampling interval. The time required for the splitter valve to collect is called the splitter ratio. The splitter ratio is automatically calculated and controls when the splitter valve needs to collect or needs to go to waste. Up to 15 samples can be collected in test tubes of 65 mls. The system can be programmed via the firmware to collect sample volumes. Methods can be protected with user names and passwords as well as hooked up to a printer for temperature and method reporting. For 21 CFR Part 11 compliance, it can also be controlled by WinSOTAX Dissolution Software.



▶ **On-line Analysis**

For on-line analysis in open loop, a UV-Vis spectrophotometer can be directly hooked up to the SOTAX CE 7smart. SOTAX has agreements in place with most major brands of spectrophotometers. Using WinSOTAX Dissolution Software, on-line measurements can be taken at predetermined times. The system automatically reads the baseline for each cell, records raw absorbance data, corrected data, concentration and % drug release in a 21 CFR Part 11 software package. For faster measurement and scanning profiles a UV Fiber Optic manifold can replace the UV-Vis spectrophotometer in the system.

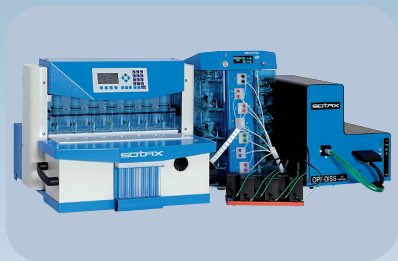

▶ **On-Offline Configuration**

In an open loop configuration, it is possible to have both a fraction collector with splitter valve and on-line UV-Vis measurements. This is very useful for dual active drug formulations and maximizes the flexibility of the system.



▶ **Automated Media Changing**

In an open loop configuration it is possible to change the media up to 3 times automatically by the addition of the MS47 media selector.

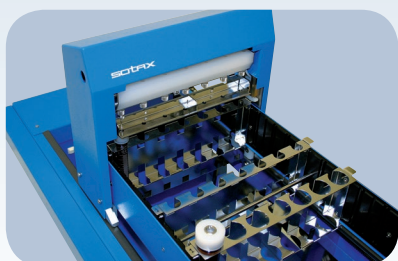

▶ **In-Line Degassing Option**

In an open loop configuration, it is possible to connect an in-line media degasser to degass the media from the reservoirs while the testing is occurring.

▶ **Case Study for Implants: A Customized System**

Depending on the route of administration and mode of action, implants can be testing in several ways. For example, an ocular implant may be testing in a closed loop configuration where as a subcutaneous implant will be tested in an open loop set up with a very low flow rate. Some implants may even require weeks of testing. For this type of dosage, a special fraction collector was developed and the pump can operate in a "stop and go" mode. In this configuration, the pump is allowed to turn on to fill the flow cell and then stops to allow for diffusion of the drug into the surrounding media. After a predefined time, the pump will come on again to refill the cell and the fraction collector collects 100% of the eluate. The fraction collector racks are capable of holding 12 or 80 ml graduated test tubes for immediate analysis.



Closed Loop Configurations

Closed loop configurations are generally used when solubility limits permit a fixed media volume, small volume dissolution (5-50 mls), or extended release testing is required. Media reservoirs have been designed based on the media volume required. These can range from test tubes or special closed loop bottles to prevent evaporative loss.

▶ **Manual Sampling**

It is possible to sample manually from a USP Apparatus 4 Closed Loop system. Samples can be withdrawn from the media reservoir via a sampling port in the bottle cap that has septum insert.

▶ **Offline Sample Collection**

Off-line sample collection for closed loop is available with the SOTAX CE 7smart connected to an autosampler. Syringes pull the desired collection volume from the media reservoir and dispense them into capped HPLC vials. The system can be programmed via the firmware to collect sample volumes at predefined time points. Methods can be protected with user names and passwords as well as hooked up to a printer for temperature and method reporting.

▶ **On-line Analysis**

For on-line analysis in closed loop, a UV-Vis spectrophotometer can be directly hooked up to the SOTAX CE 7smart. SOTAX has agreements in place with most major brands of spectrophotometers. Using WinSOTAX Dissolution Software, on-line measurements can be taken at predetermined times. The system automatically reads the baseline for each cell, records raw absorbance data, corrected data, concentration and % drug release in a 21 CFR Part 11 software package.



▶ **Case study for small volume testing: Drug Eluting Stents a Customized System**

SOTAX has designed a special closed loop system for small volume testing. This system can work in the 5–50 ml range and can be automated with a syringe autosampler. The autosampler can take up to 29 samples as low as 100 microliters accurately. The system can be programmed via the firmware to collect sample volumes at predefined time points. Methods can be protected with user names and passwords as well as hooked up to a printer for temperature and method reporting.

▶ **WinSOTAX Advanced Dissolution Software**

WinSOTAX was the first commercially available Dissolution Software package provided by any dissolution manufacturer. First introduced in 1998, WinSOTAX was developed under the latest regulations including GAMP, GALP, ISO 9001 software standards and completely complies with the rules and regulations of 21 CFR Part 11 set out by the FDA. It has evolved over the years under new



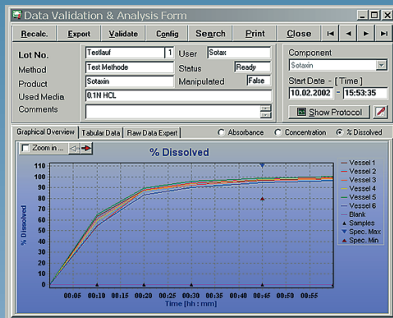

considerations and guidelines issued by the FDA regarding 21 CFR Part 11. The integrity of WinSOTAX is routinely audited by the SOTAX Quality System. SOTAX has been successfully audited by numerous pharmaceutical companies worldwide. WinSOTAX is an integrated Dissolution Software package that controls the

CE 7smart and its many systems in configurations including:

- ▶ automated On-line with spectrophotometer (open and closed loop)
- ▶ automated On-/Offline with spectrophotometer and fraction collector (open loop)
- ▶ automated media changes

WinSOTAX is also essential in the calculations involved in open and closed loop configurations. For closed loop systems, WinSOTAX calculates % dissolved much like USP 1 and 2 using a fixed volume. In an open loop configuration, % dissolved is calculated where the measurable active at a particular time interval is proportional to a defined volume that has passed through the cell. WinSOTAX automatically converts the % dissolved data into a cumulative release profile.

Other important features include:

- ▶ User-friendly method set up, results reporting, hardware control
- ▶ Real time data collection in % dissolved, abs or concentration
- ▶ Single or multi-component analysis
- ▶ Placebo or impurity subtraction
- ▶ Standard Calibration and standard bracketing
- ▶ Flow rate and temperature reporting
- ▶ Control of UV (different drivers available), sampling time points, sample volume collection
- ▶ New for 2008 scanning function during the run
- ▶ Cell Grouping allows the collection of data by grouping different cells with different testing conditions (e.g. different flow rates, different dose etc.).



WinSOTAX operates and has been validated on Windows 2000/XP/Vista and requires a minimum Pentium III. It is fully networkable and LIMS compatible. When installed, WinSOTAX is supplied with a complete validation IQ/OQ package and supported by SOTAX Certified Software Engineers worldwide.



▶ **Qualification requirements for USP Apparatus 4**

The USP requires that the temperature and flow rate of the pump be qualified at regular 6 month intervals. The temperature of the bath and media in the flow cell can be measured and certified by using the temperature measuring head. The SOTAX CP 7 Pump can also be qualified either manual within the firmware of the pump or with the automated calibration station. The flow rates are calibrated gravimetrically and can be done at a fixed flow rate or across the working range of the pump. SOTAX Services can assist you or provide you with service and preventative maintenance contracts to fulfill your qualification needs.



Technical data

Test positions	6 + 1 blank position
Water bath capacity	8 litres
Temperature range	room temperature to 45 +/- 0.2°C
Wattage	1100 VA
Height	470 mm
Depth	600 mm
Width	580 mm
Weight:	ca. 36 kg



▶ Training and Application Classes and Seminars

SOTAX provides our customers with on-site user training of our systems as well as advanced application courses. Annually since 2003, SOTAX hosts a gathering of regulatory, academia and industry experts to present applications of the Flow-Through Method used within their labs. It's an opportunity to discuss with other companies how they are using the system, validating methods and useful experiences in method development. It also gives an update as to the regulatory and USP requirements for the Flow-Through Method. Here are a just a few of the many highlights

- ▶ "The method has been accepted by FDA as a release method for the elution of sirolimus in cardiovascular stents" A Novel Method for the Elution of Sirolimus in Drug Eluting Stents
- ▶ "The impact of particle sizes and dissolution parameters can be discriminated using this instrument. Technique applied systematically to all suspensions development. The technique has been accepted by the FDA for our submission" Experience with Bioequivalence study of suspensions – Relevance of InVitro data
- ▶ "The preliminary results indicate that the modified USP Flow-Through Method with open loop configuration shows potential to better simulate digestive system in development of model-free IVIVC for BCS I and II drug products" In Vitro Dissolution Test with a Flow-Through Cell
- ▶ "The in vitro dissolution methodologies are discriminating tests capable of measuring different degrees of product performance" Performance Testing of a Suspension Dosage Form
- ▶ "Apparatus IV can be used as an orthogonal, complementary tool in trouble shooting for problems arose from USP I/II dissolution testing and for decision making" USP Apparatus IV Flow-Through Dissolution Testing A Powerful Orthogonal Technique to the Conventional USP Apparatus I/II Dissolution Techniques
- ▶ "The laminar flow that The Flow-Through Cell provides mimics in vivo conditions more effectively than Apparatus I or II" Drug Release in Ocular Implants Using Apparatus IV Dissolution with HPLC End Analysis
- ▶ "USP Apparatus IV was demonstrated as an important tool for dissolution in predicting and correlating in vivo performance of formulations" Predicting BCS II and IV Compounds by Dissolution on Apparatus IV



Bâtiment CBRV
28, Place Henri Dunant
FR-63000 Clermont-Ferrand
Phone +33 4 73 17 83 98
Fax +33 4 73 17 83 99
E-mail contact@sps-pharma.com
www.sps-pharma.com

Method Development and Feasibility Services

SOTAX Pharma Services or SPS was created as the first contract research organization based solely on one principle: dissolution testing. With our expertise in dissolution, SPS offers feasibility studies, method development assistance and advanced training classes. We specialize in Novel Dosage forms and therefore the use of the Flow-Through Method.